

Announcements

CAES Gaisler Products
Elaine Gonsalves

GR740 
 **USER DAY | 2022**

15th of December 2022
Webinar

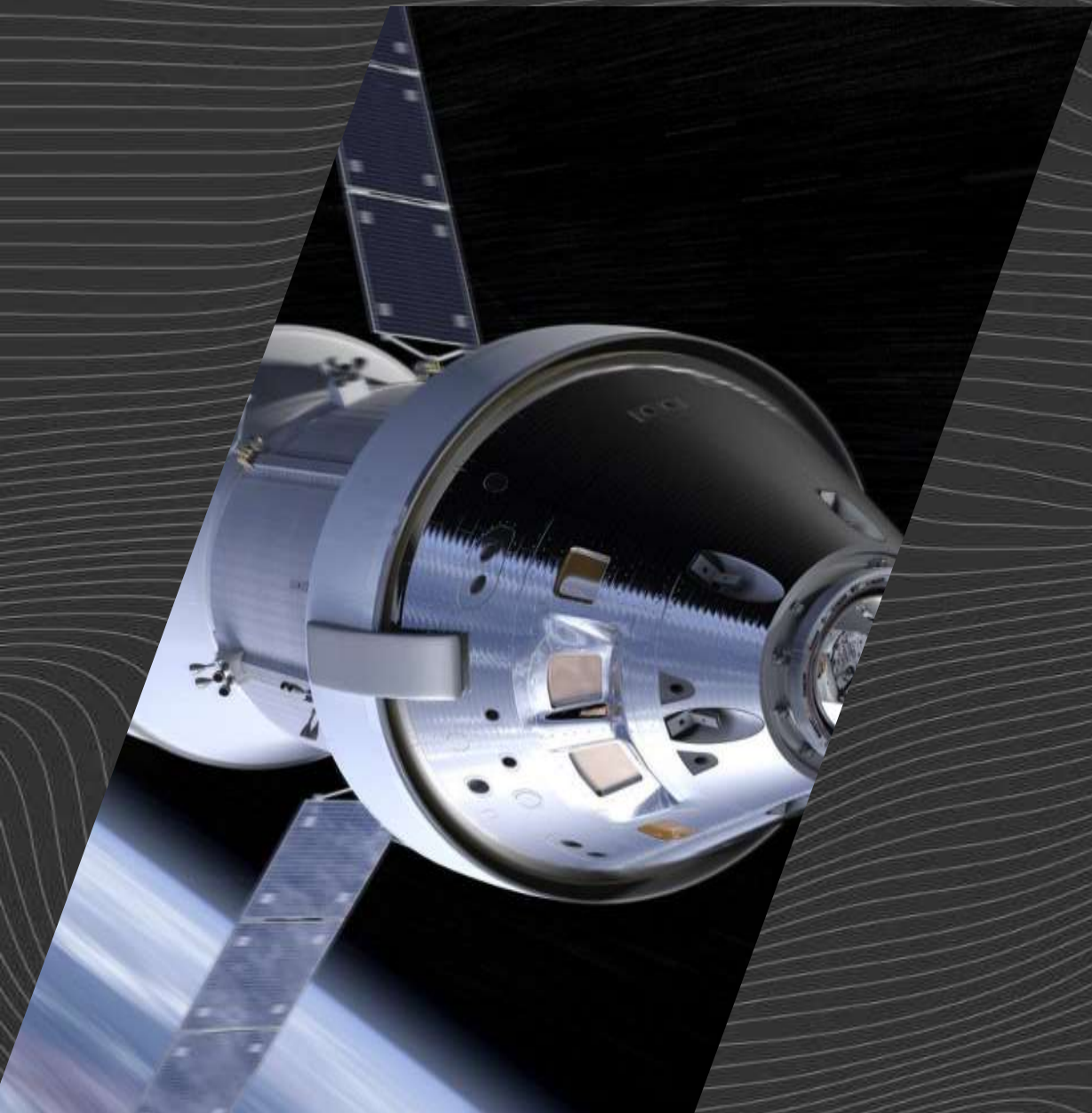



CAES



GR740

**Quad-Core LEON4FT
System-on-Chip**

QML-V
Space-qualified



ECSS-Q-ST-60-13C
Class 2 LAT



GR-CPCI-GR740 Development Board

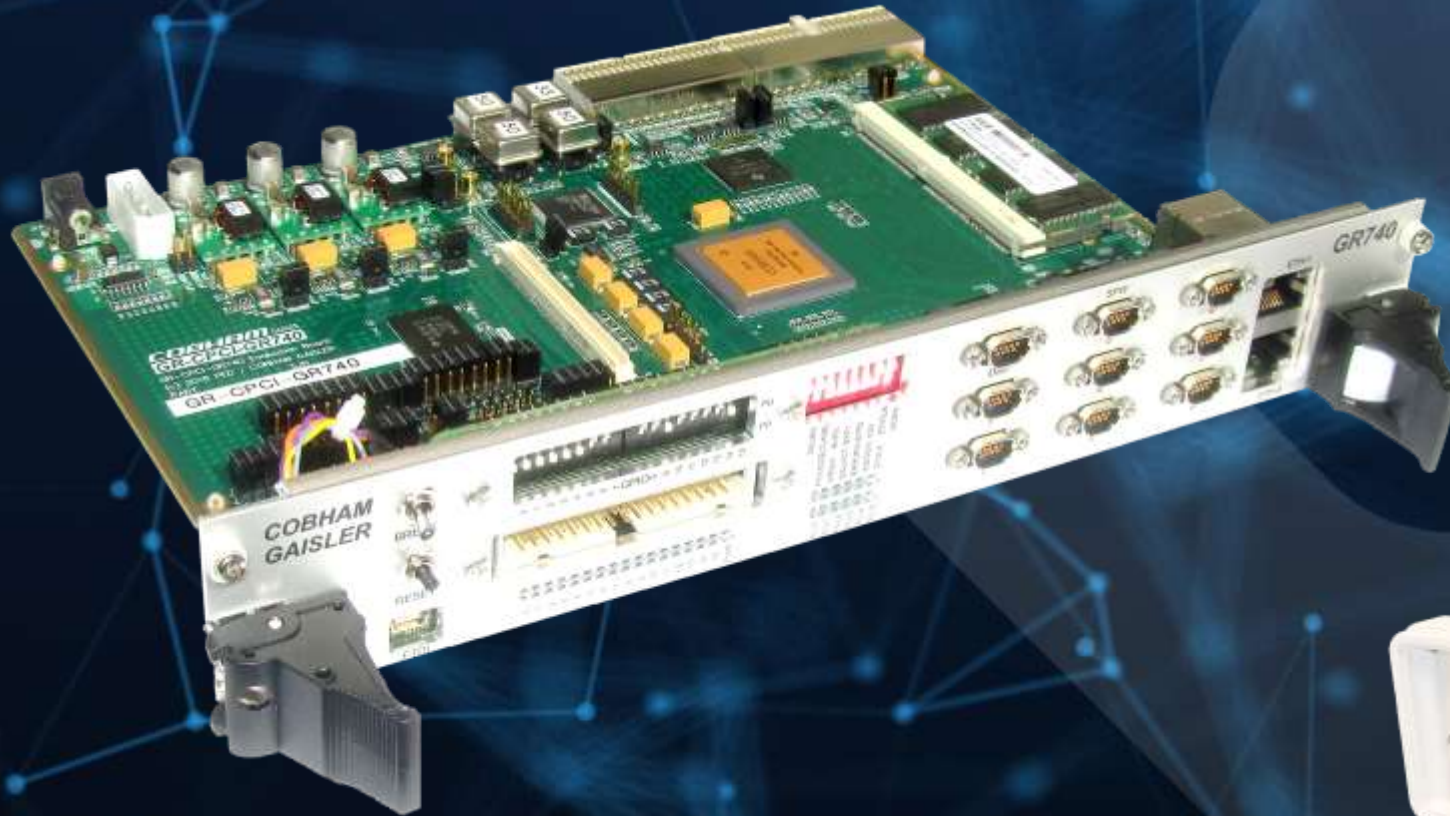

GR-CPCI-GR740 Development Box

GR-VPX-GR740 Development Board



GR740-MINI Evaluation Board

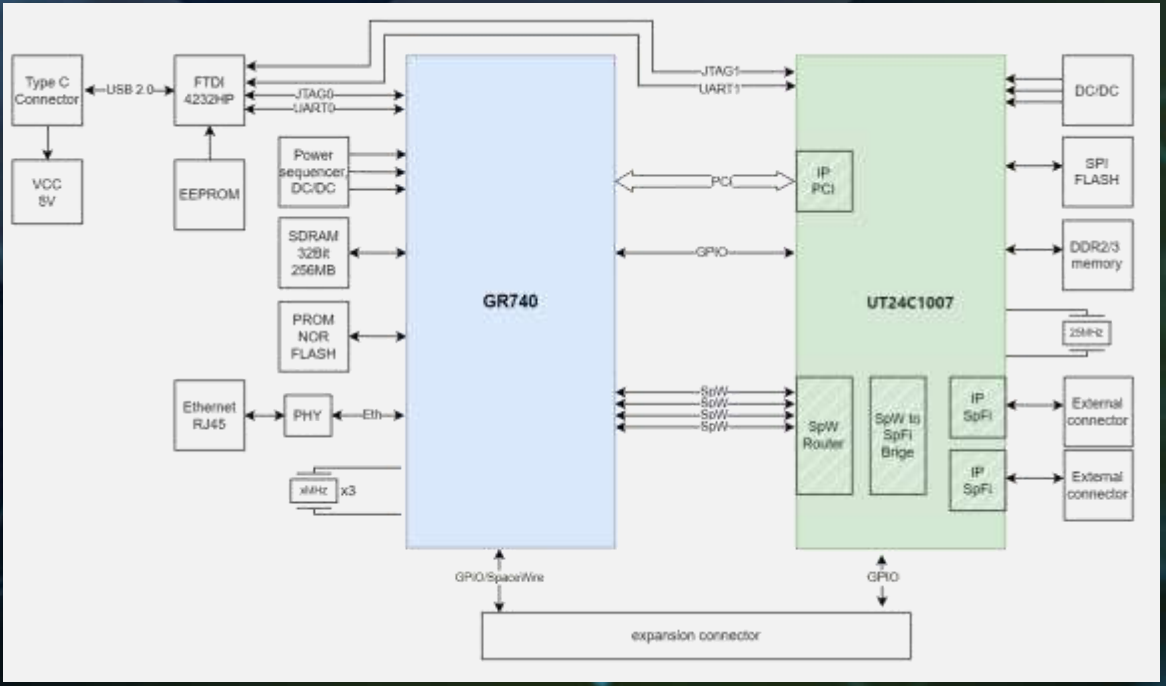
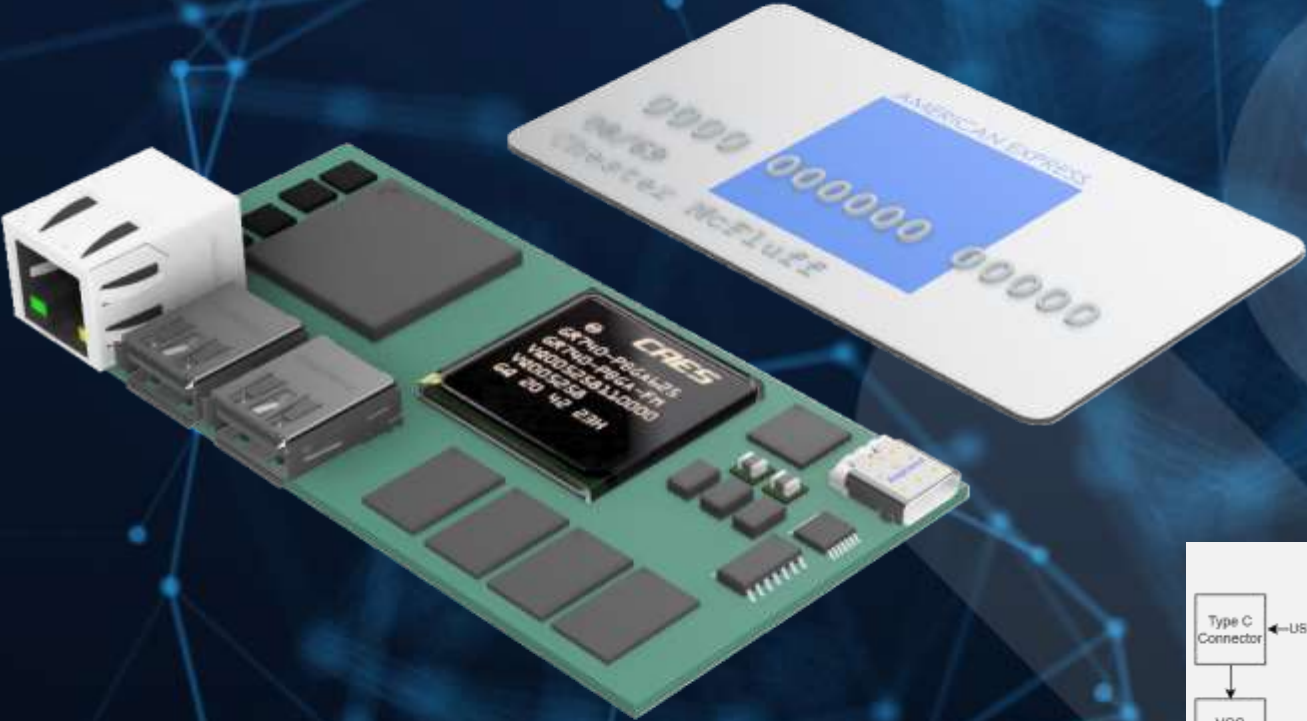

GR-CSP1-GR740 Flight Board

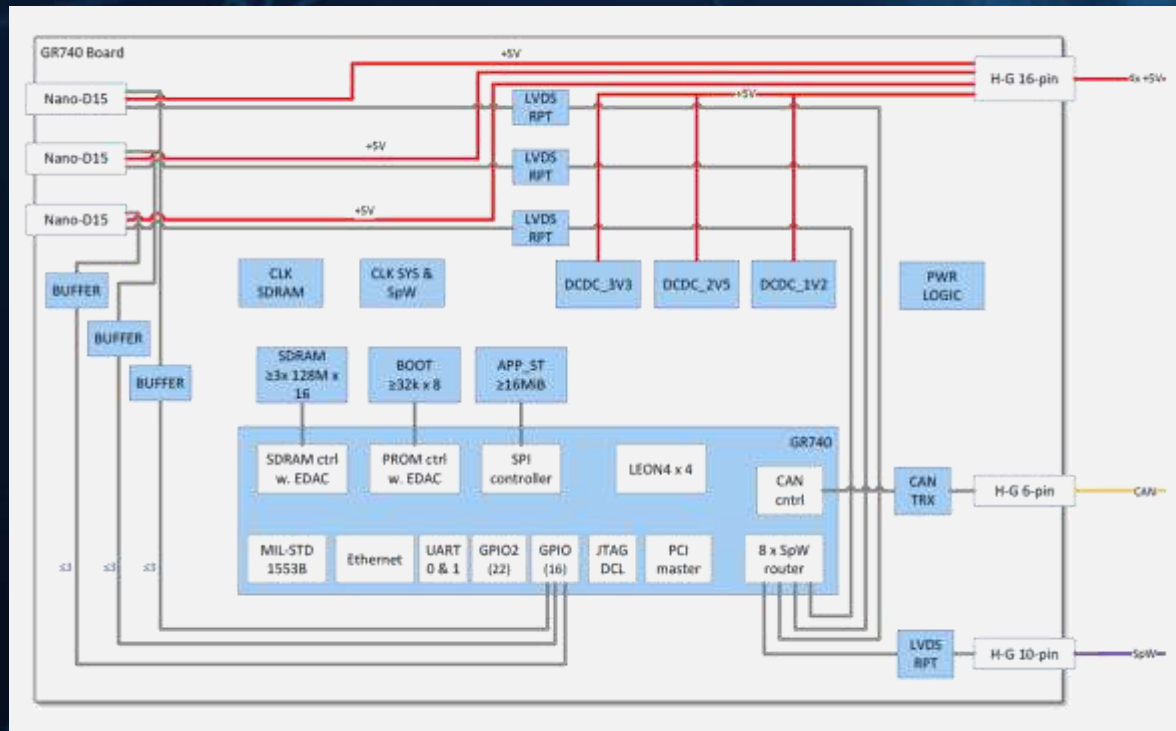

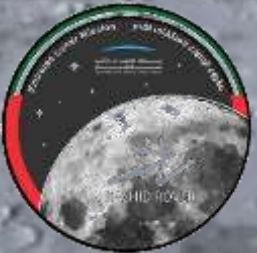

GR-SBC-GR740 Flight Board

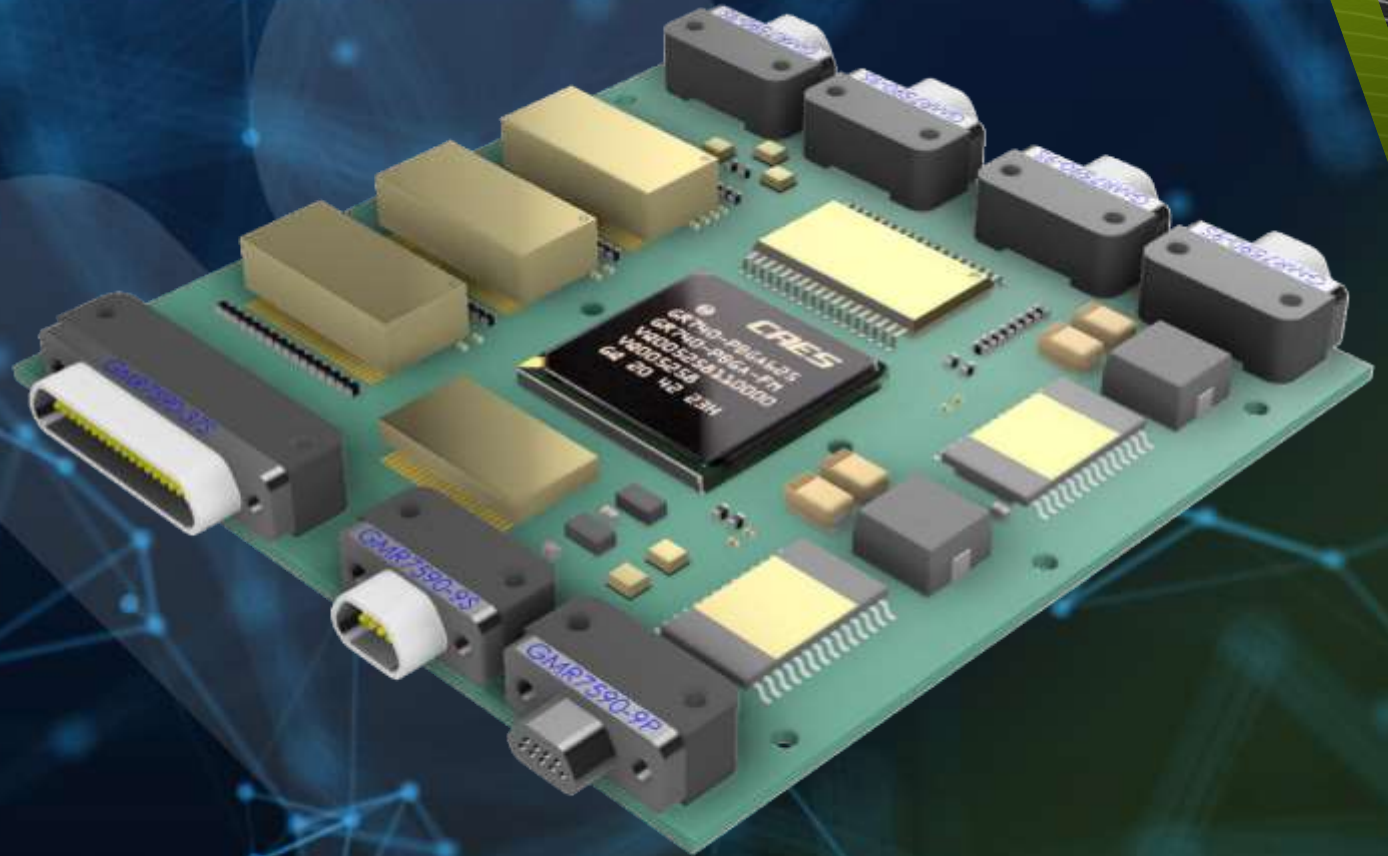
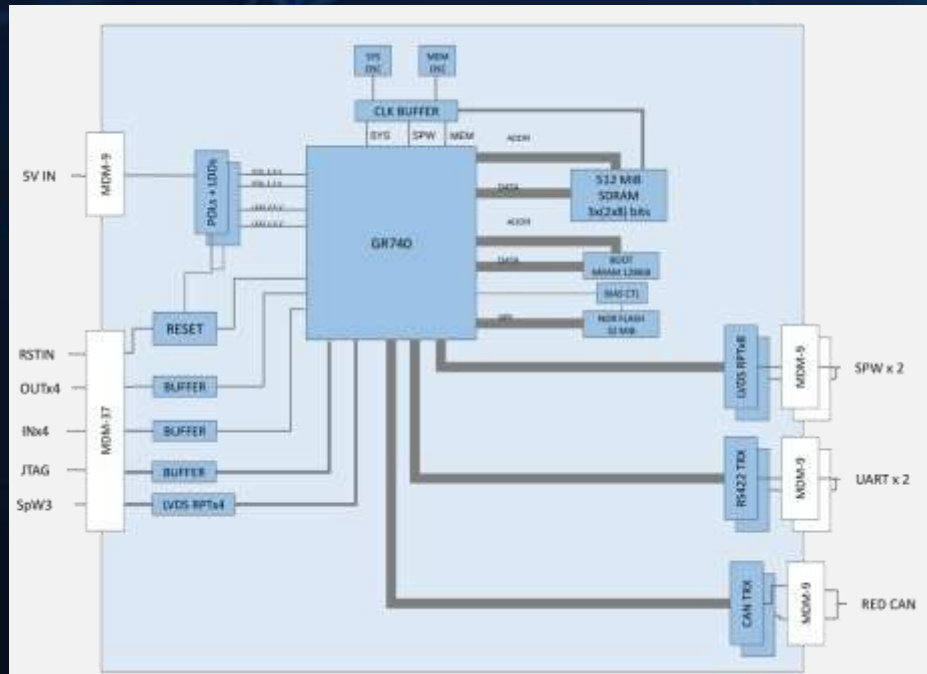

Rymdstyrelsen
Swedish National Space Agency



F-series

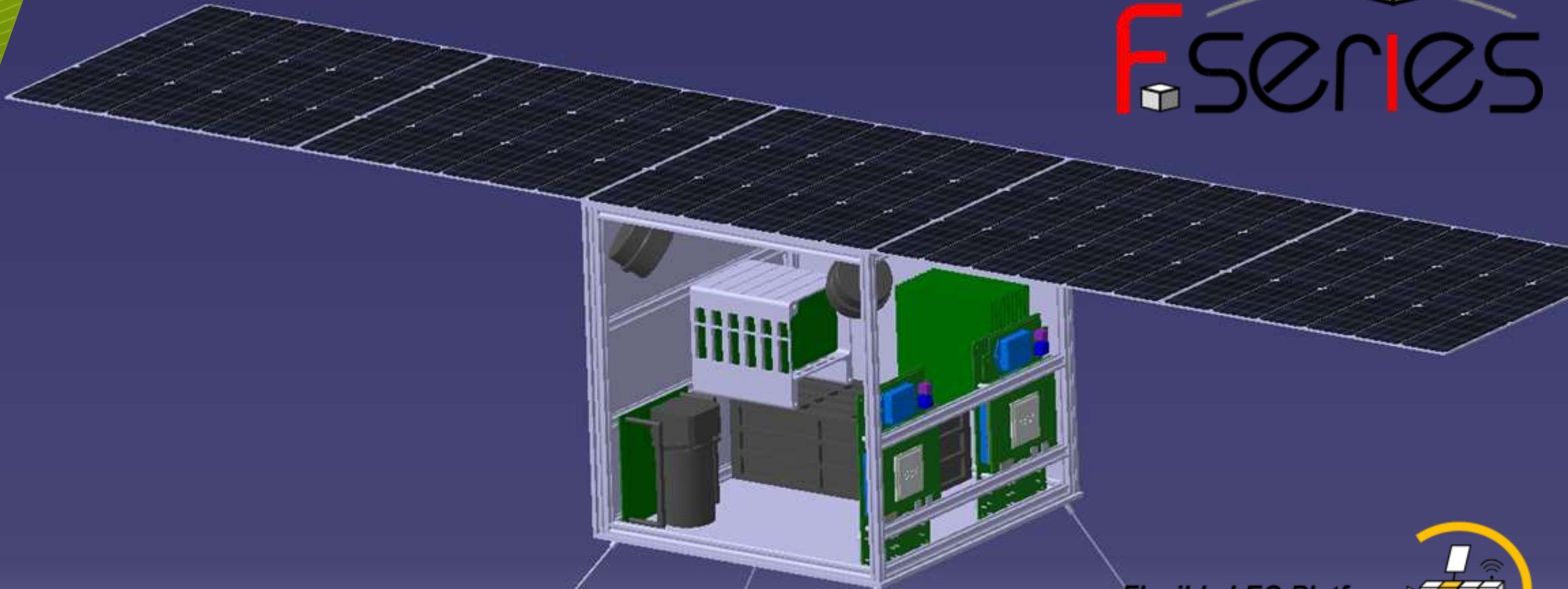

Flexible LEO Platform



Flexible LEO Cube



AIRBUS
DEFENCE & SPACE

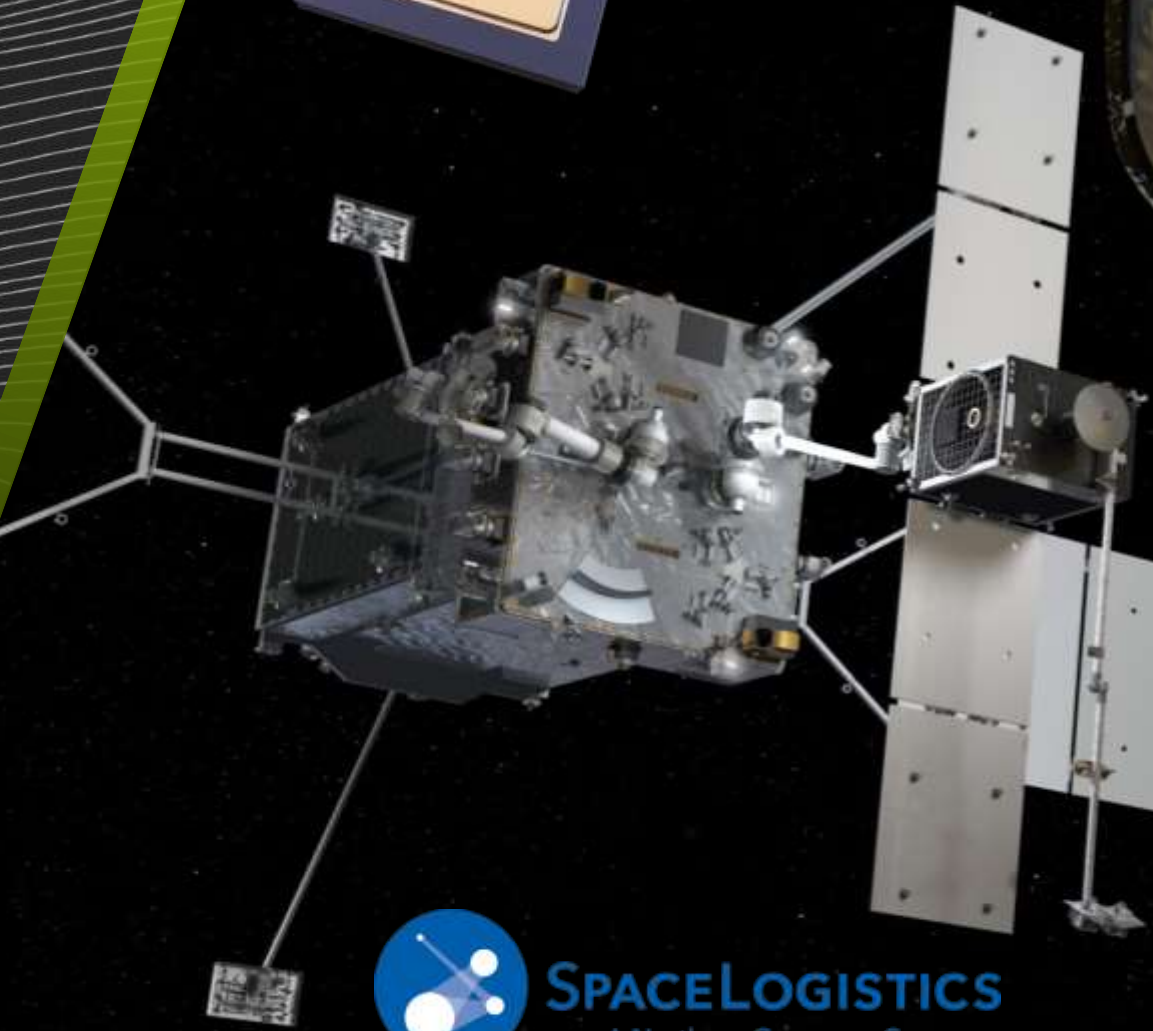
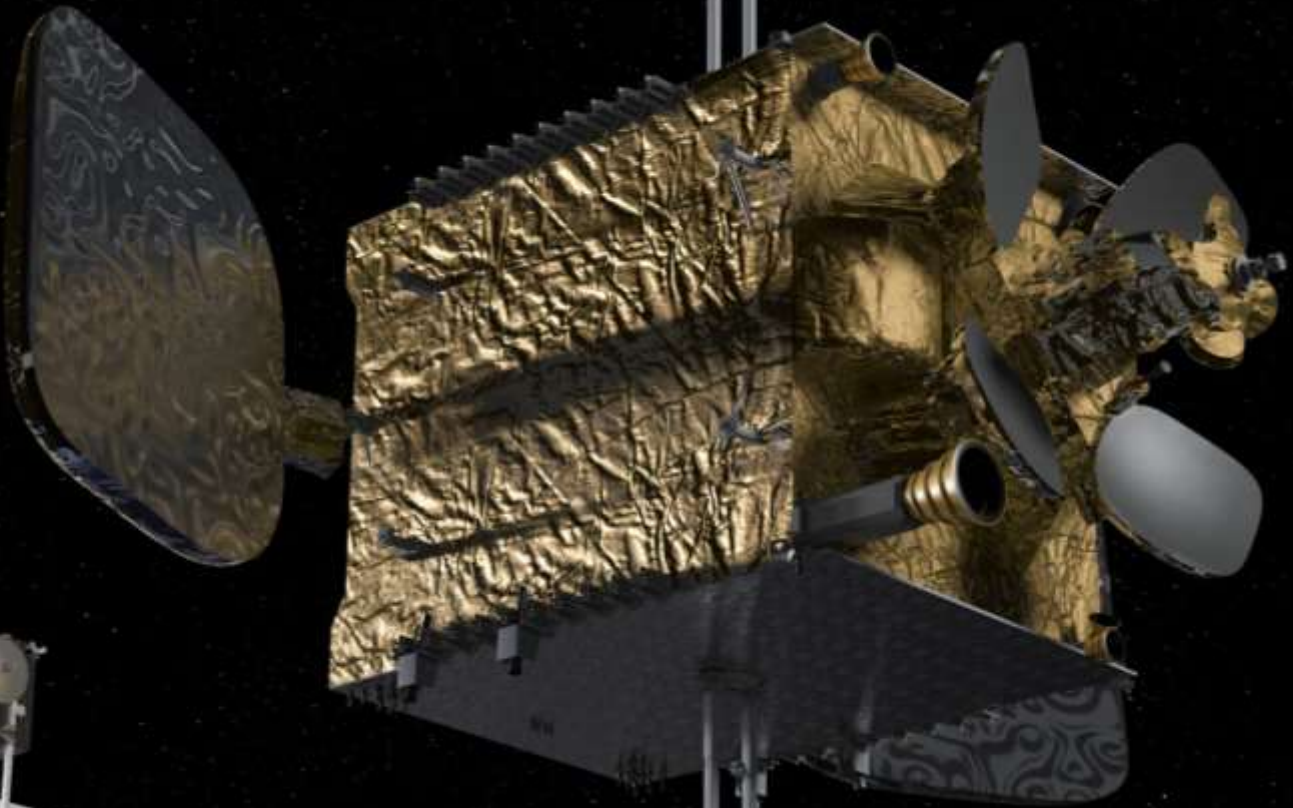
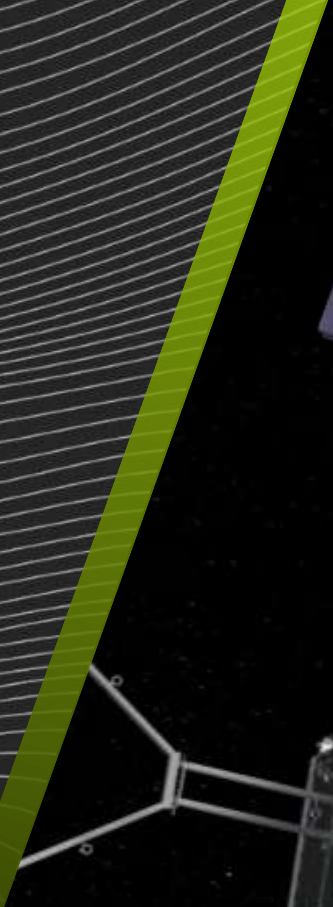

SPACELOGISTICS
A Northrop Grumman Company

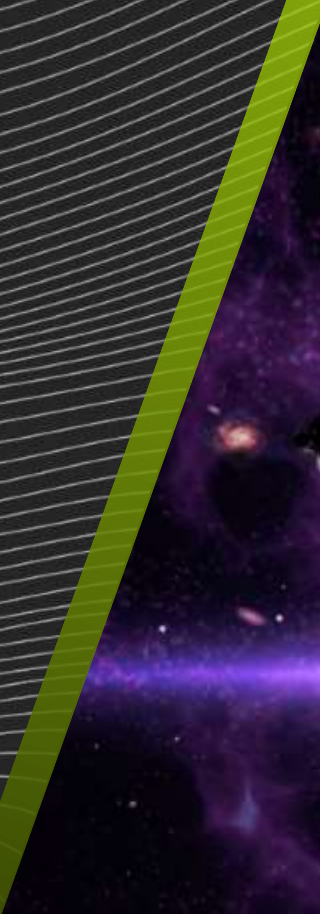







**GR716B Data Sheet &
User Manual**

BCC GR716B BSP Bare Metal

TSIM3-GR716 Simulator

GRMON3-GR716 Debugger

GR716B-MINI - 2023 Q2

GR716B-CP - 2023 Q2

GR716B-MS - 2024 Q2

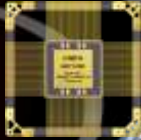
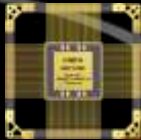
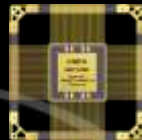
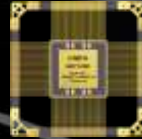
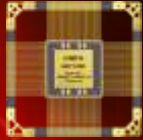

noel-V



LEON

LEON

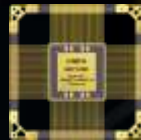



OIAR
SYSTEMS

CAES
PIONEERING ADVANCED ELECTRONICS

 **RISC-V[®]**

CRAES

PIONEERING ADVANCED ELECTRONICS